

OZAKS
ALÜMİNYUM • PROFİL

www.ozaksaluminium.com



About US

Hakkımızda

2016 yılında fason üretim tesisi olarak kurulan firmamız bugün hizmetini tam mamül satışı olarak sürdürmektedir. **Güvenilir hizmetimiz sayesinde sektörün genç, dinamik ve en iddialı şirketleri arasında bulunmaktadır.** Özaks alüminyum profil olarak üretimin her aşamasında kaliteye önem vererek 1. sınıf hammadde ve 1. sınıf ekipmanlarla isinde uzman üretim kadrosuyla sorunsuz müşteri memnuniyetini hedef alarak her gün büyüyen kapasite ile alüminyum boy kulp, sürgü sistemleri ve mobilya aksesuarları dünyasında yerini almış bulunmaktadır.

Misyonumuz

Kusursuz hizmeti, kalitesi ile Türkiye ve dünya çapında tercih edilen marka olmaktır.

Vizyonumuz

Tedarikçilerden müşterilerimize kadar sistemimize dahil olan tüm unsurları **kalite politikamız çerçevesinde buluşturup** müşterilerimizin talep ettiklerini ve oluşturduğumuz yenilikleri **son teknolojiyi kullanarak** tam zamanında sunabilmektir.

ÖZAKS

ALÜMİNYUM • PROFİL

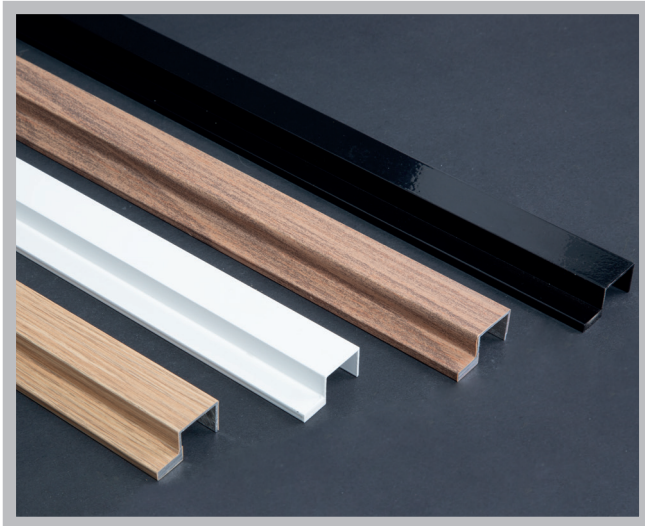

Alüminyum Boy Kulplar Aluminium Handle / Aluminium Langer Griff

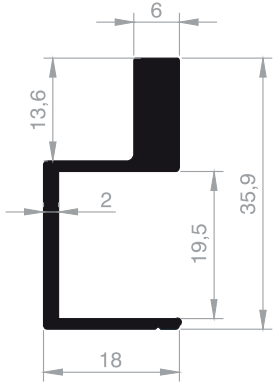

OZ 3046

AĞIRLIK
WEIGHT : 0,463 kg/m
GEWICHT

BOY KULP
LONG HANDLE
LANGER GRIFF

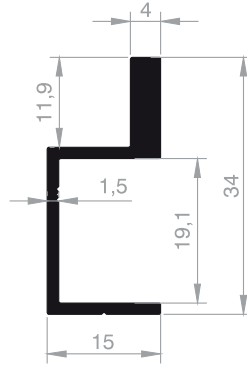

OZ 4597

AĞIRLIK
WEIGHT : 0,332 kg/m
GEWICHT

BOY KULP
LONG HANDLE
LANGER GRIFF

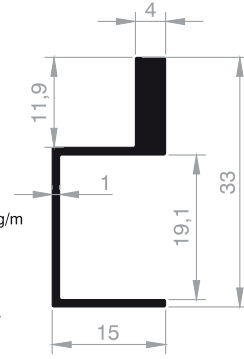

OZ 3032

AĞIRLIK
WEIGHT : 0,261 kg/m
GEWICHT

BOY KULP
LONG HANDLE
LANGER GRIFF

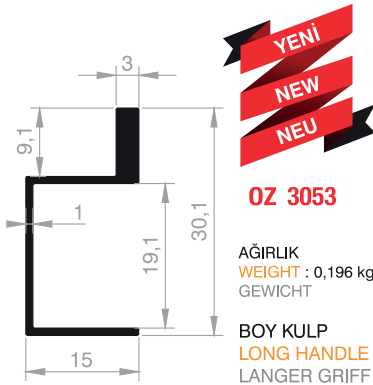

OZ 3053

AĞIRLIK
WEIGHT : 0,196 kg/m
GEWICHT

BOY KULP
LONG HANDLE
LANGER GRIFF

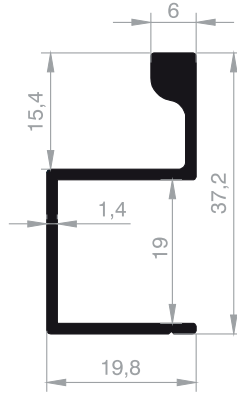

OZ 3619

AĞIRLIK
WEIGHT : 0,363 kg/m
GEWICHT

BOY KULP
LONG HANDLE
LANGER GRIFF

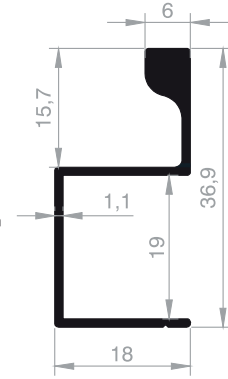

OZ 4517

AĞIRLIK
WEIGHT : 0,297 kg/m
GEWICHT

BOY KULP
LONG HANDLE
LANGER GRIFF

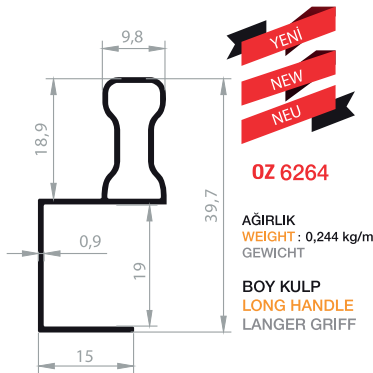

OZ 6264

AĞIRLIK
WEIGHT : 0,244 kg/m
GEWICHT

BOY KULP
LONG HANDLE
LANGER GRIFF

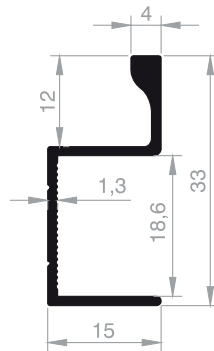

OZ 4431

AĞIRLIK
WEIGHT : 0,231 kg/m
GEWICHT

BOY KULP
LONG HANDLE
LANGER GRIFF

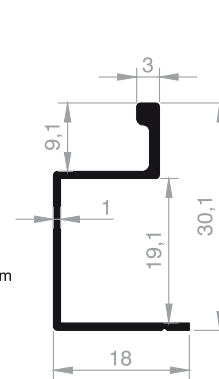

OZ 5675

AĞIRLIK
WEIGHT : 0,176 kg/m
GEWICHT

BOY KULP
LONG HANDLE
LANGER GRIFF

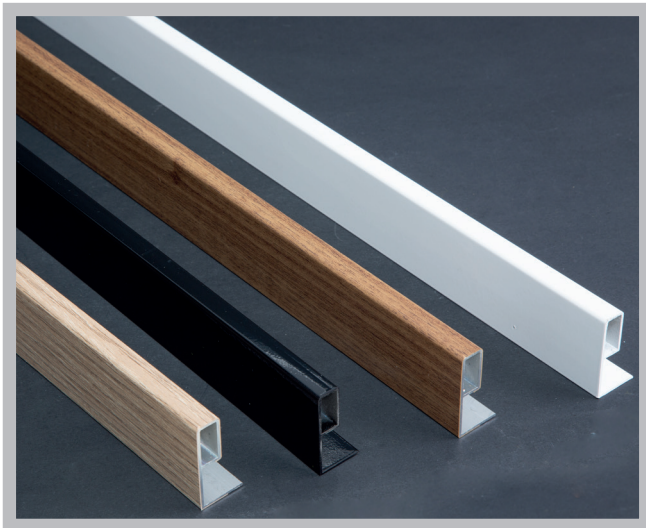

Alüminyum Boy Kulplar Aluminium Handle / Aluminium Langer Griff

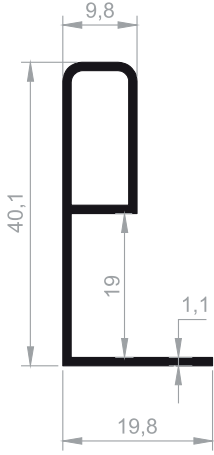

OZ 3041

AĞIRLIK
WEIGHT : 0,280 kg/m
GEWICHT

BOY KULP
LONG HANDLE
LANGER GRIFF

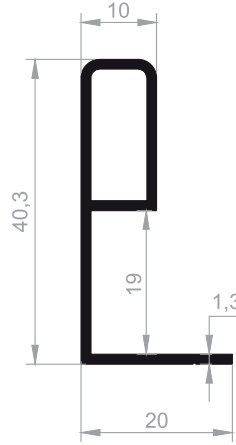

OZ 2653

AĞIRLIK
WEIGHT : 0,300 kg/m
GEWICHT

BOY KULP
LONG HANDLE
LANGER GRIFF

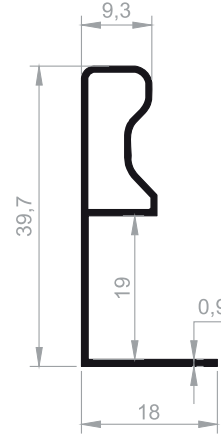

OZ 6262

AĞIRLIK
WEIGHT : 0,226 kg/m
GEWICHT

BOY KULP
LONG HANDLE
LANGER GRIFF

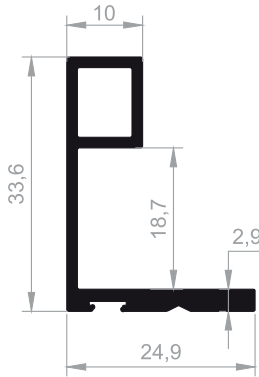

OZ 7071

AĞIRLIK
WEIGHT : 0,394 kg/m
GEWICHT

BOY KULP
LONG HANDLE
LANGER GRIFF

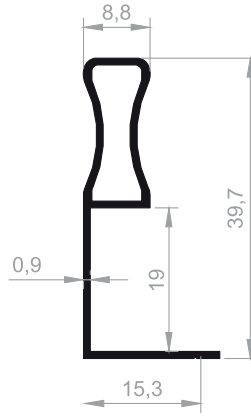

OZ 6237

AĞIRLIK
WEIGHT : 0,224 kg/m
GEWICHT

BOY KULP
LONG HANDLE
LANGER GRIFF

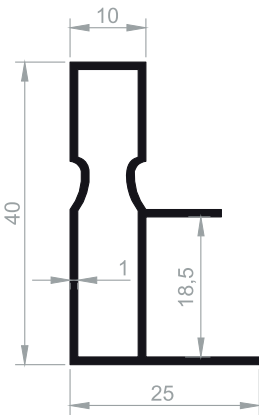

OZ 3907

AĞIRLIK
WEIGHT : 0,333 kg/m
GEWICHT

BOY KULP
LONG HANDLE
LANGER GRIFF

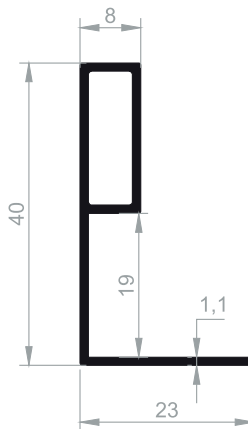

OZ 4639

AĞIRLIK
WEIGHT : 0,283 kg/m
GEWICHT

BOY KULP
LONG HANDLE
LANGER GRIFF

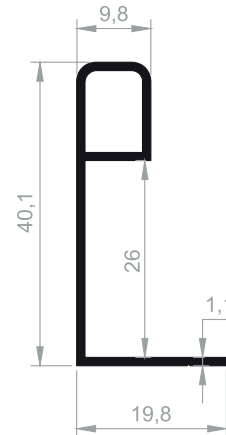

OZ 6054

AĞIRLIK
WEIGHT : 0,254 kg/m
GEWICHT

BOY KULP
LONG HANDLE
LANGER GRIFF

OZ 1102



OZ 5910



OZ 4658

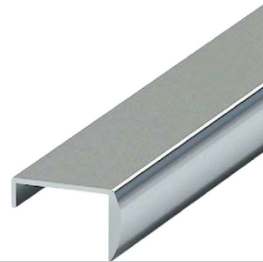

OZ 1506



OZ 6233



OZ 5698



Alüminyum Boy Kulplar Aluminium Handle / Aluminium Langer Griff

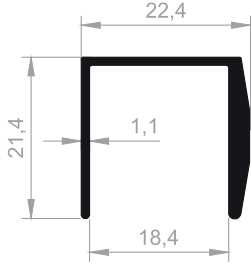

OZ 1102

AĞIRLIK
WEIGHT : 0,240 kg/m
GEWICHT
BOY KULP KARŞILIĞI
CROSS HANDLE
GEKREUZTER GRIFF

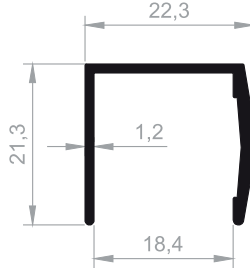

OZ 3620

AĞIRLIK
WEIGHT : 0,220 kg/m
GEWICHT
BOY KULP KARŞILIĞI
CROSS HANDLE
GEKREUZTER GRIFF

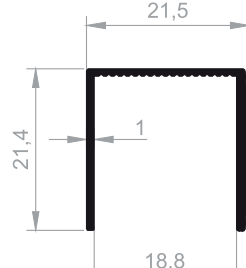

OZ 4807

AĞIRLIK
WEIGHT : 0,196 kg/m
GEWICHT
BOY KULP KARŞILIĞI
CROSS HANDLE
GEKREUZTER GRIFF

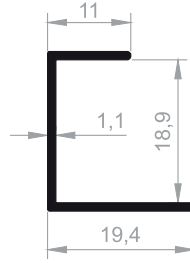

OZ 3042

AĞIRLIK
WEIGHT : 0,151 kg/m
GEWICHT
BOY KULP KARŞILIĞI
CROSS HANDLE
GEKREUZTER GRIFF

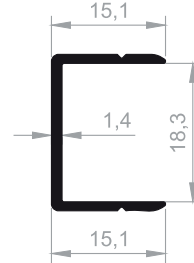

OZ 1506

AĞIRLIK
WEIGHT : 0,165 kg/m
GEWICHT
BOY KULP KARŞILIĞI
CROSS HANDLE
GEKREUZTER GRIFF

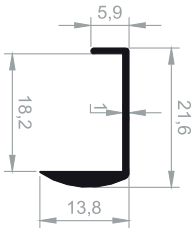

OZ 4658

AĞIRLIK
WEIGHT : 0,165 kg/m
GEWICHT
BOY KULP KARŞILIĞI
CROSS HANDLE
GEKREUZTER GRIFF

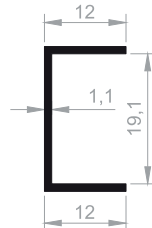

OZ 3033

AĞIRLIK
WEIGHT : 0,129 kg/m
GEWICHT
BOY KULP KARŞILIĞI
CROSS HANDLE
GEKREUZTER GRIFF

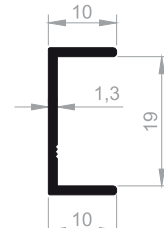

OZ 4598

AĞIRLIK
WEIGHT : 0,140 kg/m
GEWICHT

OZ 1672



OZ 3548



OZ 3983



OZ 5475



Alüminyum Boy Kulplar Aluminium Handle / Aluminium Langer Griff

YENİ
NEW
NEU

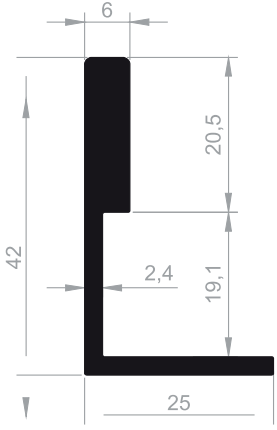

OZ 4584

AĞIRLIK
WEIGHT : 0,617 kg/m
GEWICHT

BOY KULP
LONG HANDLE
LANGER GRIFF

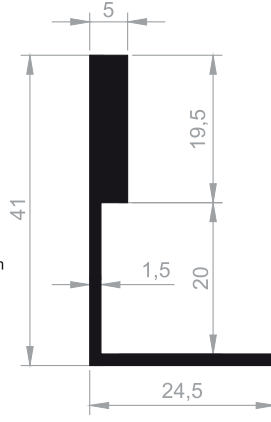

OZ 4622

AĞIRLIK
WEIGHT : 0,445 kg/m
GEWICHT

BOY KULP
LONG HANDLE
LANGER GRIFF

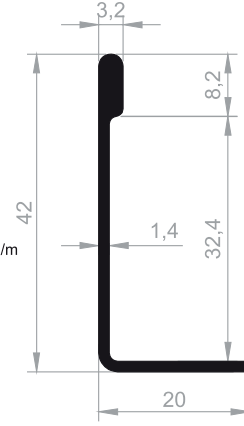

OZ 1672

AĞIRLIK
WEIGHT : 0,265 kg/m
GEWICHT

BOY KULP
LONG HANDLE
LANGER GRIFF

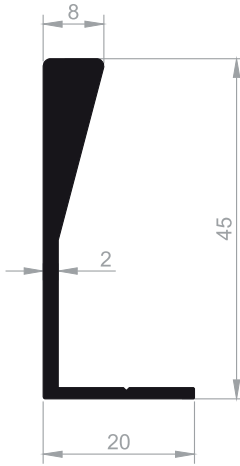

YENİ
NEW
NEU

OZ 5475

AĞIRLIK
WEIGHT : 0,520 kg/m
GEWICHT

BOY KULP
LONG HANDLE
LANGER GRIFF

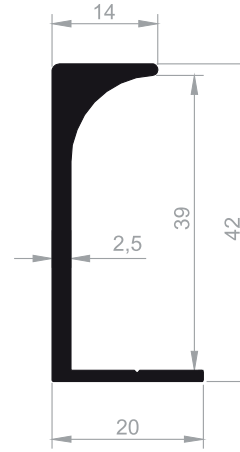

YENİ
NEW
NEU

OZ 5474

AĞIRLIK
WEIGHT : 0,476 kg/m
GEWICHT

BOY KULP
LONG HANDLE
LANGER GRIFF

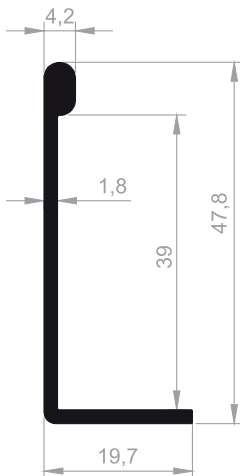

YENİ
NEW
NEU

OZ 6168

AĞIRLIK
WEIGHT : 0,355 kg/m
GEWICHT

BOY KULP
LONG HANDLE
LANGER GRIFF

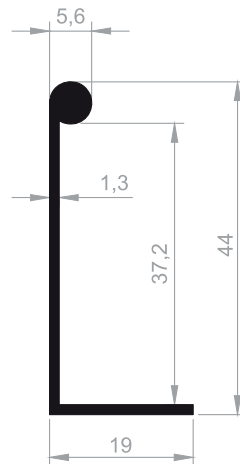

YENİ
NEW
NEU

OZ 4840

AĞIRLIK
WEIGHT : 0,268 kg/m
GEWICHT

BOY KULP
LONG HANDLE
LANGER GRIFF

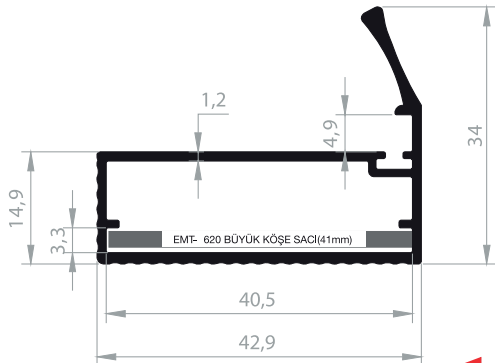

OZ 5720

AĞIRLIK
WEIGHT : 0,488 kg/m
GEWICHT

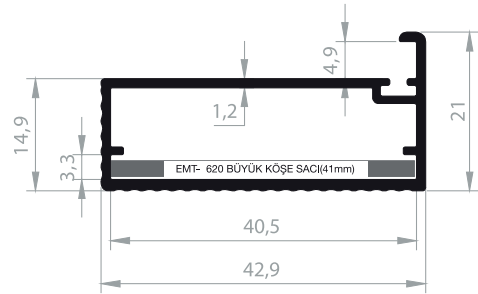

OZ 5719

AĞIRLIK
WEIGHT : 0,423 kg/m
GEWICHT



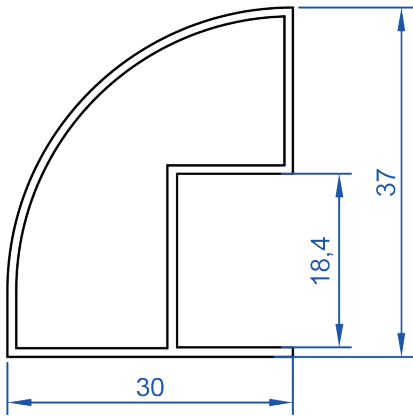

OZ 7101

AĞIRLIK
WEIGHT : 0.325 kg/m
GEWICHT

BOY KULP
LONG HANDLE
LANGER GRIFF

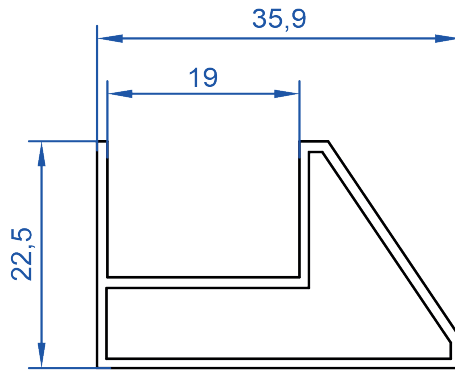

OZ 3037

AĞIRLIK
WEIGHT : 0.340 kg/m
GEWICHT

BOY KULP
LONG HANDLE
LANGER GRIFF

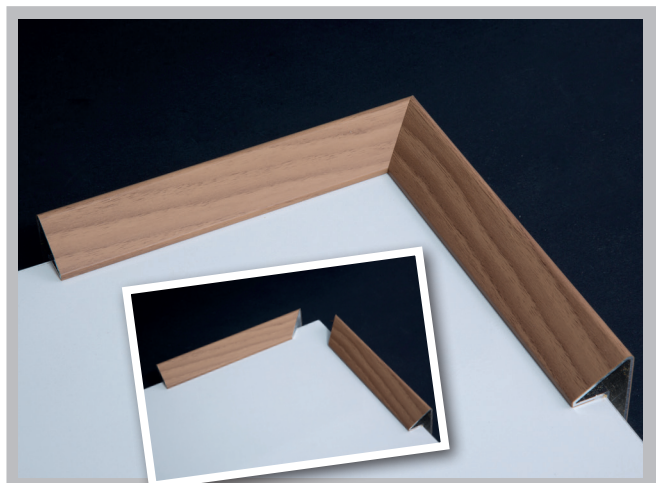
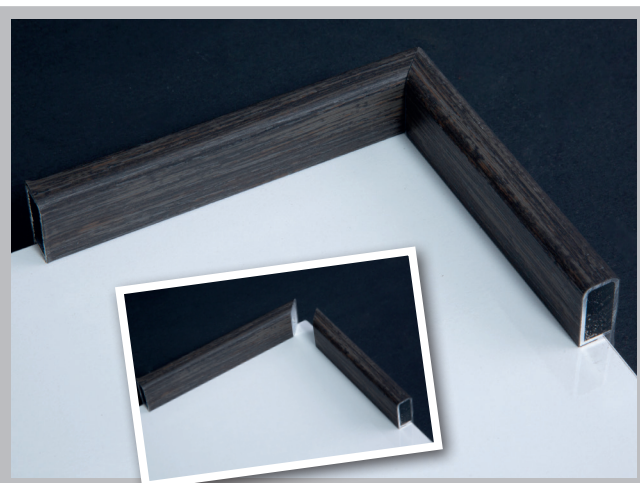
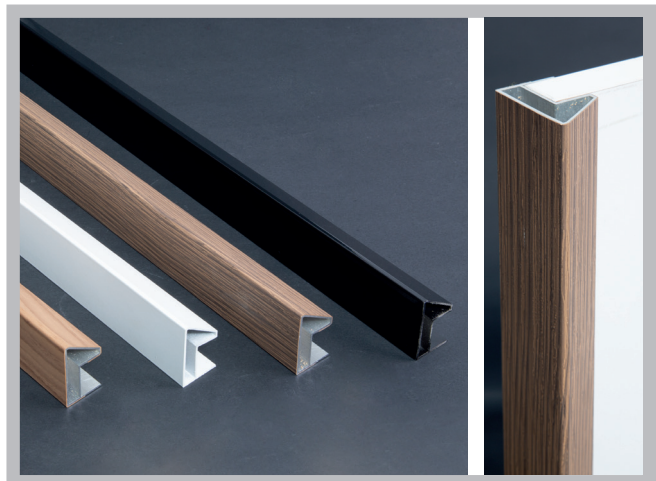
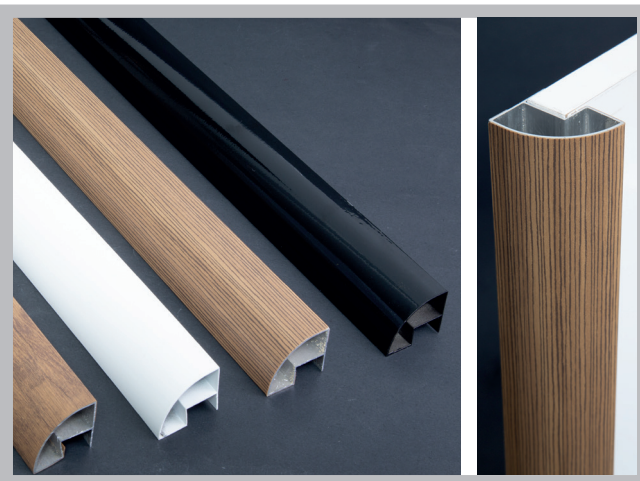

OZ 1195



OZ 5680



OZ 4512



OZ 1116



Sürgü Sistem Rayları Sliding System Rails

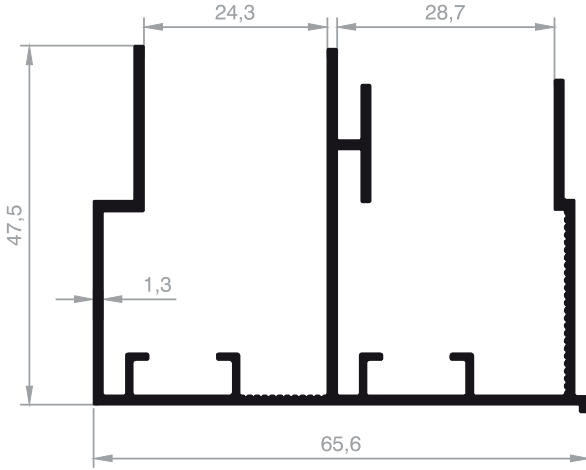

OZ 7082

AĞIRLIK
WEIGHT : 0,835 kg/m
GEWICHT

ÜSTTEN ASMALI RAY
TOP HANGED RAIL
OBERE HÄNGESCHIENE



OZ 1195

AĞIRLIK
WEIGHT : 0,265 kg/m
GEWICHT

ALT RAY / BOTTOM RAIL / BODENSCHIENE

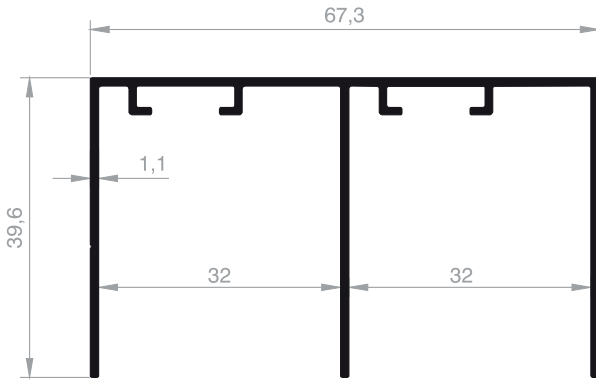

OZ 1132

AĞIRLIK
WEIGHT : 0,608 kg/m
GEWICHT

ÜST RAY
UPPER RAIL
DECKENSCHIENE

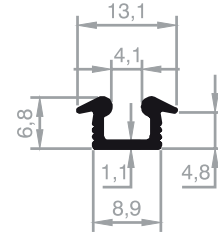

OZ 1025

AĞIRLIK
WEIGHT : 0,082 kg/m
GEWICHT

ALT ÜST GÖMME RAY
BUILT IN BOTTOM TOP RAIL
EINGEBAUT UNTER OBER SCHIENE

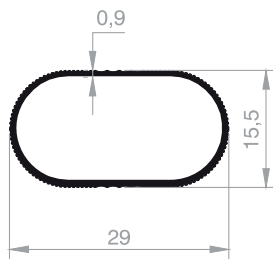

OZ 9023

AĞIRLIK
WEIGHT : 0,160 kg/m
GEWICHT

GENİŞ OVAL ASKILIK
LARGE OVAL HANGER
GROBE OVALE AUFHÄNGUNG

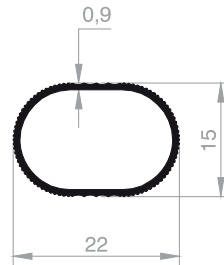

OZ 9024

AĞIRLIK
WEIGHT : 0,135 kg/m
GEWICHT

DAR OVAL ASKILIK
NARROW OVAL HANGER
KURZE OVALE AUFHÄNGUNG

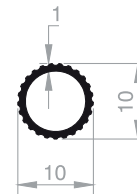

OZ 9028

AĞIRLIK
WEIGHT : 0,085 kg/m
GEWICHT

PANTOLONLUK
TROUSERS PROFILE
HOSENPROFIL

RYM 1000

Sürme Kapak Mekanizması

Üst mekanizma

Alt mekanizma

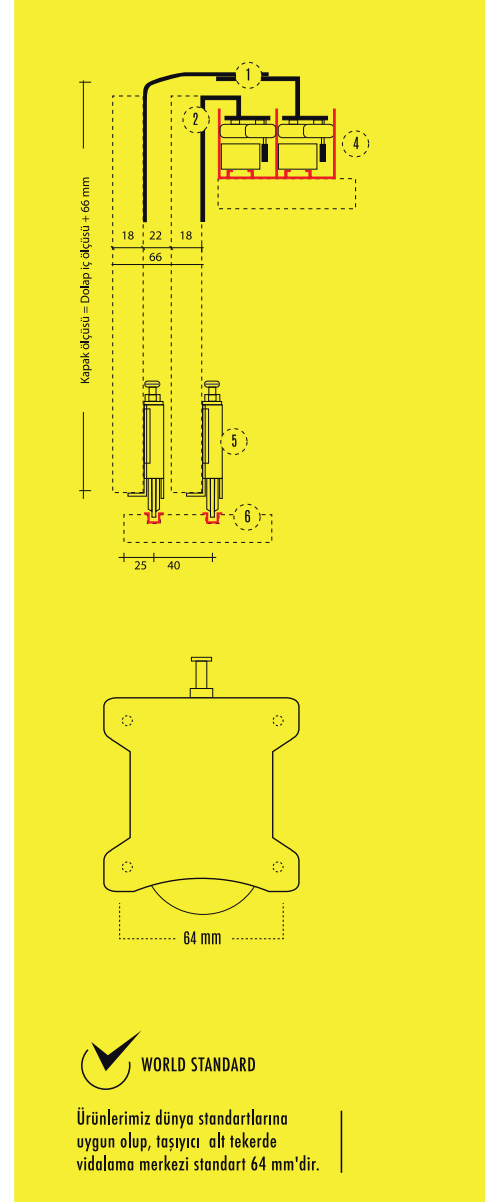
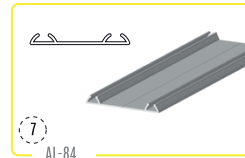
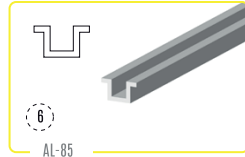
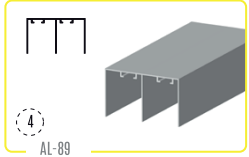
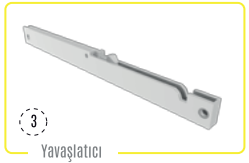
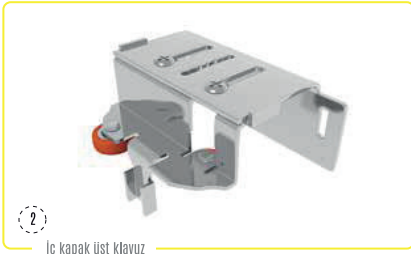
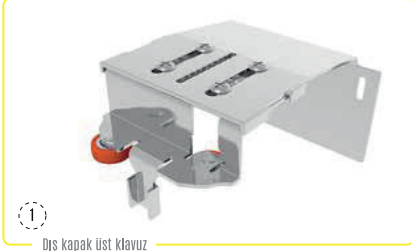

RYM 1000

Sürme Kapak Mekanizması

YENİ ÜRÜN

İç ve dış kapak ta mesafe ayarı

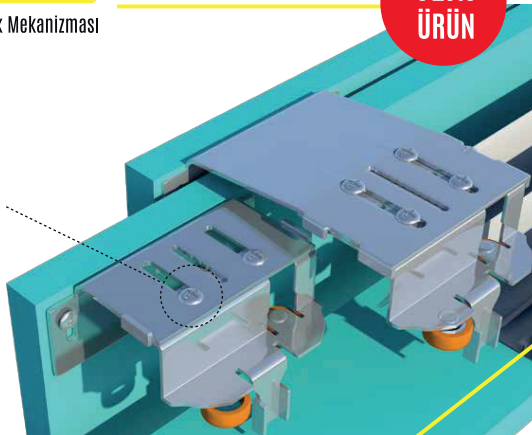

● KOLAY
Montaj

● DENGE
Minimum Sarsıntı

● AYARLI
mesafe ayarlı

✓ Ürünümüz PKM 80 mekanizma ile beraber uygulanır. Bu kombinasyon ağır sistemin verdiği şok görünümünü vermekle beraber, taşıyıcı mekanizma alt bazanın üstünde hareket ettiği için ağır sistemi kapaklarda sıkma oluşan sarkma bel verme ve kapakların çıkması gibi olumsuzluklar yaşanmaz.

✓ Dolaysıyla hem estetik hem de KOLAY mekanik bakım edilebilir oluruz. Ön ve arka kapak; üst ray içine takılabilen yavaşlatıcı mekanizmalar sayesinde sağ ve sol olmak üzere her iki yönde de yavaşlatıcı durma özelliği gösterir.

✓ Ürünümüzü farklı kalın ilk etken dış kapakın 36 mm ayar mesafesinin alınmasıyla yanısıra iç kapakın da 20 mm ayar mesafesinin alınmasıdır. Diğer bir etken ise mekanizmaya uygulanan özel radius büküm sonucunda gardroblara ön taraftan bakıldığında rahatsız eden metal görünümü ortadan kalkmaktadır.

✓ Çift rulmanlı olma sebebi ile kapaklardaki sallanmayı engellemesidir.

PKM 86 AY-87

Sürme Kapak Mekanizması

Üst mekanizma

Alt mekanizma



1 Dış kapak üst klavuz



2 İç kapak üst klavuz

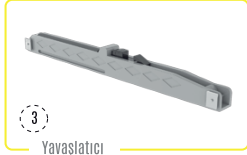

3 Yavaşlatıcı

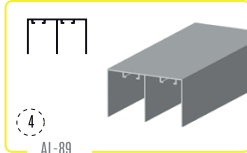

4 AL-89

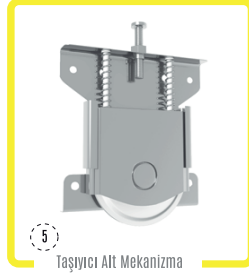

5 Taşıyıcı Alt Mekanizma

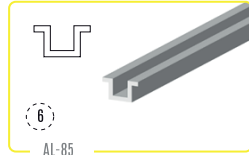

6 AL-85

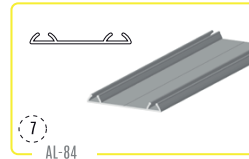

7 AL-84

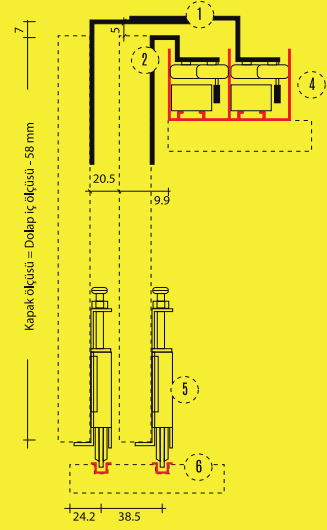

Ürünlerimiz dünya standartlarına uygun olup, taşıyıcı alt tekerde vidalama merkezi standart 64 mm'dir.

PKM 86 AY 87

Sürme Kapak Mekanizması



Çift rulman sistem

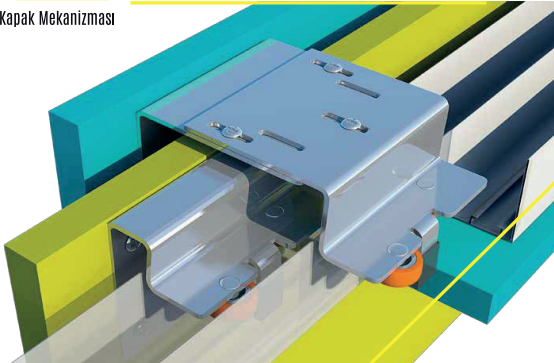

● KOLAY
Montaj

● DENGE
Minimum Sarsıntı

● AYARLI
mesafe ayarlı

- ✓ Ürünümüz PKM 80 mekanizma ile beraber uygulanır. Bu kombinasyon ağır sistemin verdiği şık görünümü vermekle beraber, taşıyıcı mekanizma altı bazanın üstünde hareket ettiği için ağır sistemi kapaklarda sıkça oluşan sararma bel verme ve kapakların çıkması gibi olumsuzluklar yaşanmaz.
- ✓ Dolayısıyla hem estetik hem de KOLAY mekanik aksam elde etmiş oluruz. Ön ve arka kapak; üst ray içine takılabilen yavaşlatıcı mekanizmalar sayesinde sağ ve sol olmak üzere her iki yönde de yavaşlatarak durma özelliği gösterir.
- ✓ Ürünümüzü diğerlerinden farklı olmasını sağlayan aksam; mekanizmaların ÇİFT RULMANLI sistemle çalışmasıdır. Bu sayede üst rayı çift taraflı baskı uygulayarak kapaklardaki boşluğu dolayısıyla kapak sallanmalarını engeller.
- ✓ Ürünümüzün diğer önemli özelliği ise dış kapak mekanizmasının mesafe AYARININ olmasıdır. Bu özelliği sayesinde kapak kalınlığına göre ayarlanabilir olması ve iç ve dış kapakların geçiş esnasında birbirinde sürtünmemesidir.

PKM 84 AY-85

Sürme Kapak Mekanizması

Üst mekanizma

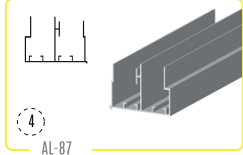
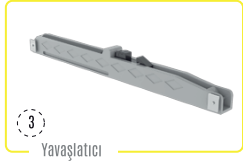
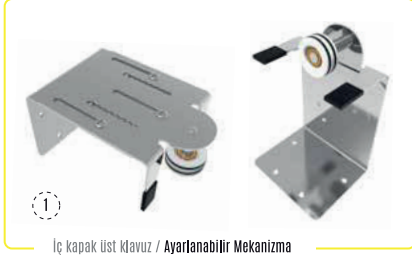

Alt mekanizma

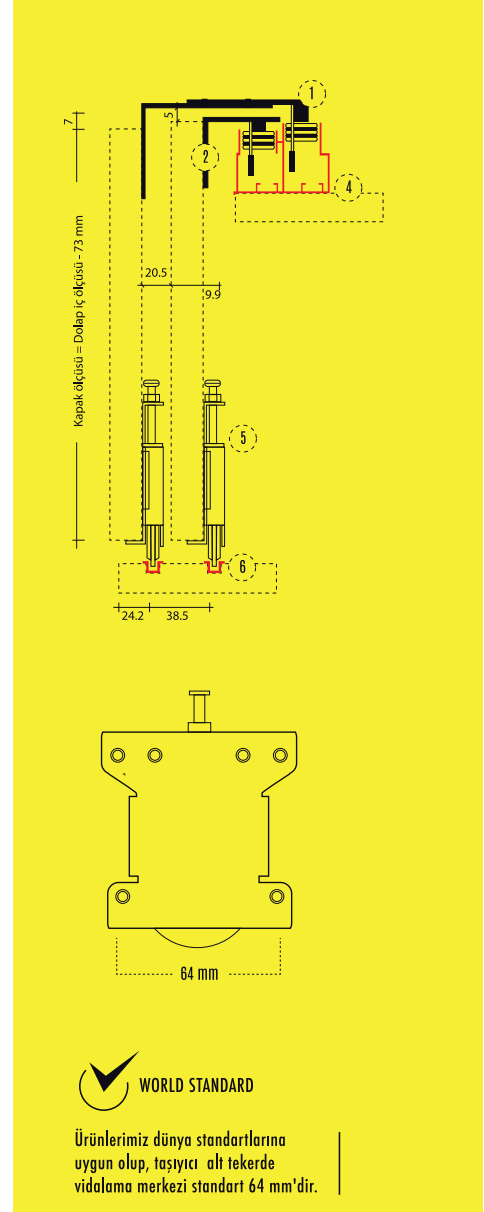
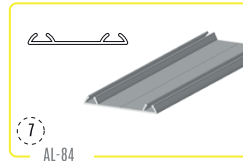
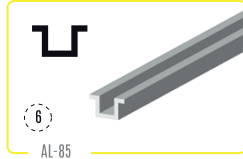
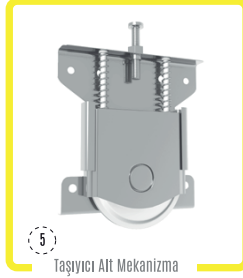

PKM 84 AY 85

Sürme Kapak Mekanizması

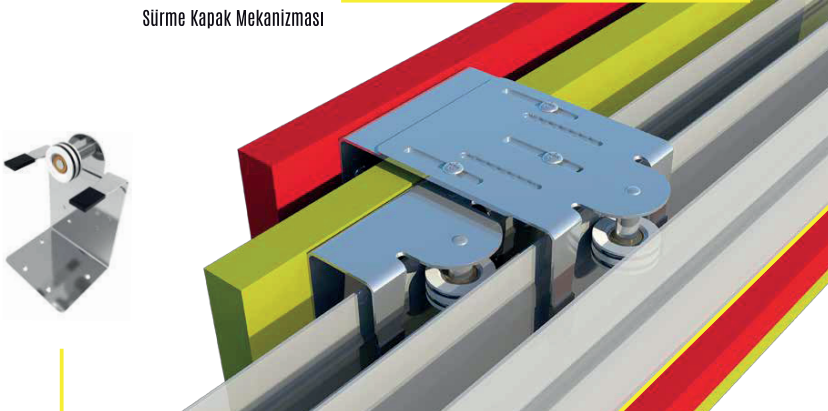

● KOLAY
Montaj

● DENGE
Minimum Sarsıntı

● AYARLI
mesafe ayarlı

✓ Ürünümüz PKM 80 mekanizma ile beraber uygulanır. Bu kombinasyon ağır sistemin verdiği şok görünümü vermekle beraber, taşıyıcı mekanizma altı bazanın üstünde hareket ettiği için ağır sistemi kapaklarda sıkça oluşan sarkma bel verme ve kapakların çıkması gibi olumsuzluklar yaşanmaz.

✓ Delaysızla hem estetik hem de KOLAY mekanik aksam elde etmiş oluruz. Ön ve arka kapak; üst ray içine takılabilen yavaşlatıcı mekanizmalar sayesinde sağ ve sol olmak üzere her iki yönde de yavaşlatarak durma özelliği gösterir.

✓ Ürünümüzün diğer önemli özelliği ise dış kapak mekanizmasından mesafe AYARLANIR. Bu özelliği sayesinde kapak kalınlığına göre ayarlanabilir olması ve iç ve dış kapakların geçiş esnasında birbirinde sürtünmemesidir.

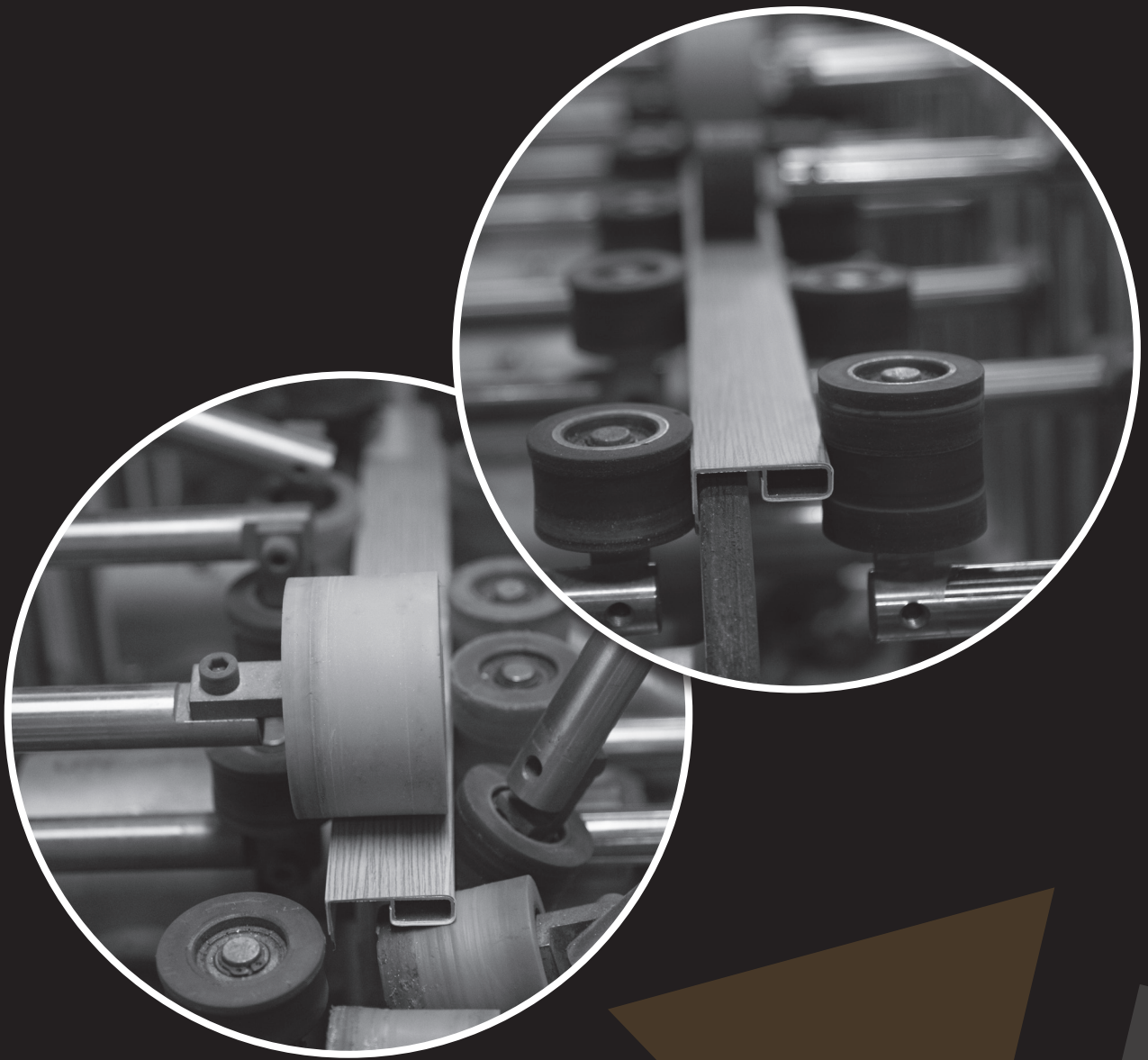



A: Mahmudiye Mh. Şen Sk. No:8/A İnegöl / BURSA
T: 0224 713 1234 - (Whatsapp : 0543 277 62 08 - 0533 032 44 55)

© ozaksaluminyum

f özaksalüminyum